

# SG 6010

---

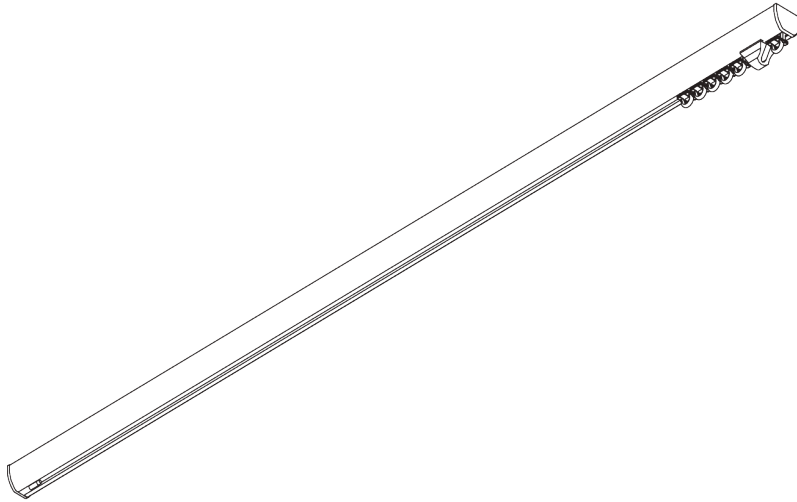
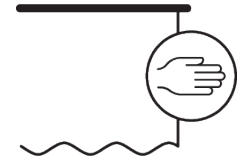

## PRODUCT INFORMATION

- **Operation:** hand
- **Range:** S - M
- **Fitting:** ceiling, wall
- **Colours:** white RAL 9016, black RAL 9005 or anodised aluminum, special colours possible
- **Fabrics:** refer to Silent Gliss fabric collection

### **Features:**

- 2-component (2C) glider technology
- Wave (2C)
- Bendable

# SYSTEM SPECIFICATIONS

## A. PROFILE

Profile and bending information

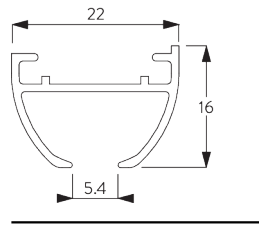

SG 6010p

Profile

Radius:  
✓ 15 cm, >25 cm

## B. HOW TO MEASURE

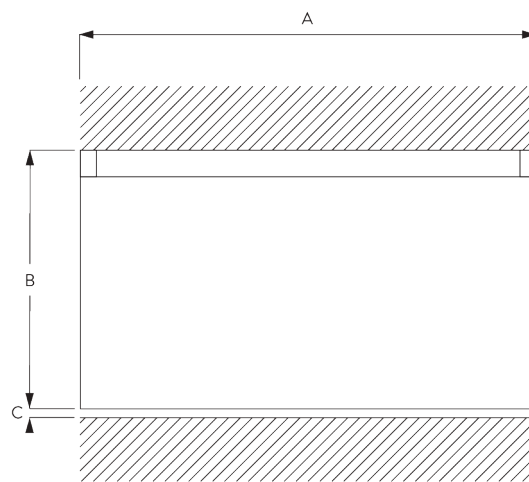

A: System width  
B: System height  
C: Distance between floor and fabric

## C. SPECIFICATION TEXT

**Silent Gliss SG 6010 Hand Operated Curtain Track System.** Comprises aluminium profile SG 6010 supplied made to measure powder coated in white / black. Supplied as standard with 2C gliders SG 11300 at 14/m, 2 end covers SG 6018 and 2 end stops SG 6065. Top fixed with clamp SG 3825 at 500mm centres. Wall fix with SG Smart Fix brackets SG 11201-11205 and SG 3832 or SG 3825 / SG Square Smart Fix brackets SG 11210-11215 and SG 3832 or SG 3825 / Universal Smart Fix brackets SG 11154-11156 and SG 3832 or SG 3825. Silent Gliss Wave option is available using 60mm glider cord SG 11303 / 80mm glider cord SG 11302.

# FITTING

## A. FITTING INFORMATION

Fixing points

For detailed fitting information, visit the Silent Gliss website.

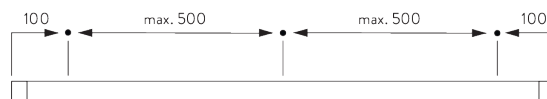

## B. CEILING FITTING

### Clamp SG 3825

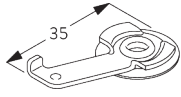
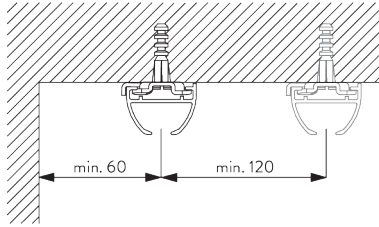

**SG 3825**

Clamp

### Bracket SG 3832

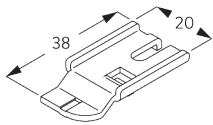
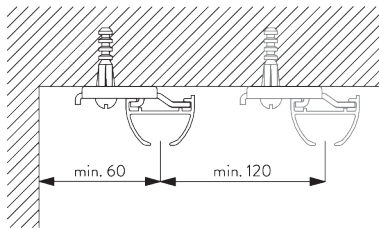

**SG 3832**

Bracket

## C. WALL FITTING

### Smart Fix

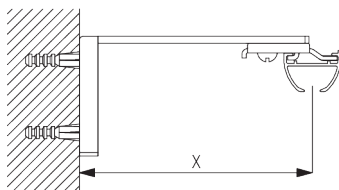

**Smart Fix SG 11200 - SG 11205 and bracket SG 3832:**  
Screw SG 10492 (M4x8) needed.

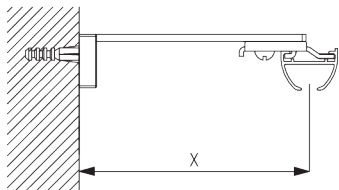

**Square Smart Fix SG 11210 - SG 11215 and bracket SG 3832:**  
Screw SG 10492 (M4x8) needed.

Smart Fix	X mm (SG 3832)	X mm (SG 3825)
SG 11200 / SG 11210	70	52
SG 11201 / SG 11211	90	72
SG 11202 / SG 11212	110	92
SG 11203 / SG 11213	130	112
SG 11204 / SG 11214	160	142
SG 11205 / SG 11215	210	192
SG 11154	120-148	102-130
SG 11155	150-178	132-160
SG 11156	200-228	182-210

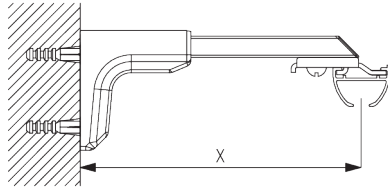

**Universal Smart Fix SG 11154 - SG 11156 and bracket SG 3832:**

Screw SG 10407 (M4x10) needed.

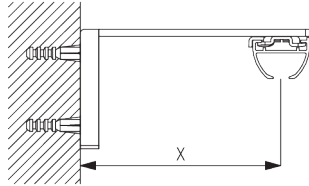

**Smart Fix SG 11200 - SG 11205 and clamp SG 3825:**

Screw SG 10074 (M4x8) needed.

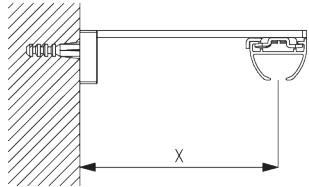

**Square Smart Fix SG 11210 - SG 11215 and clamp SG 3825:**

Screw SG 10074 (M4x8) needed.

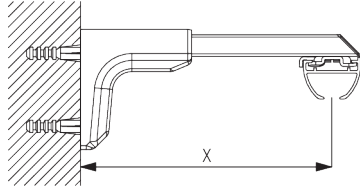

**Universal Smart Fix SG 11154 - SG 11156 and clamp SG 3825:**

Screw SG 11158 (M4x12) needed.

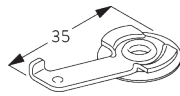

**SG 3825**  
Clamp

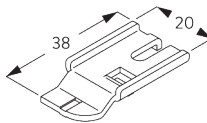

**SG 3832**  
Bracket



**SG 10407**  
Pan head screw M4x10



**SG 10492**  
Pan head screw M4x8



**SG 11158**  
Countersunk head screw  
M4x12

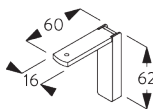

**SG 11200**  
Smart Fix 60 mm

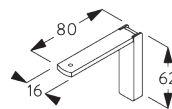

**SG 11201**  
Smart Fix 80 mm

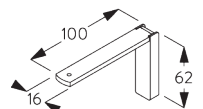

**SG 11202**  
Smart Fix 100 mm

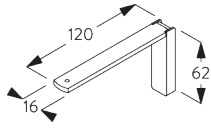

**SG 11203**  
Smart Fix 120 mm

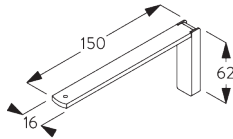

**SG 11204**  
Smart Fix 150 mm

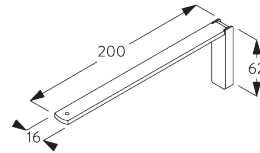

**SG 11205**  
Smart Fix 200 mm

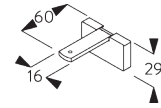

**SG 11210**  
Square Smart Fix 60 mm

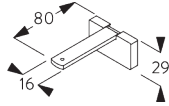

**SG 11211**  
Square Smart Fix 80 mm

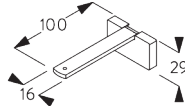

**SG 11212**  
Square Smart Fix 100 mm

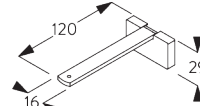

**SG 11213**  
Square Smart Fix 120 mm

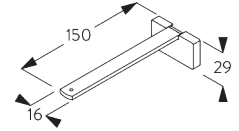

**SG 11214**  
Square Smart Fix 150 mm

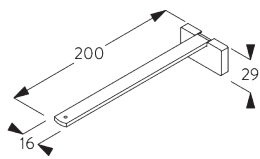

**SG 11215**  
Square Smart Fix 200 mm

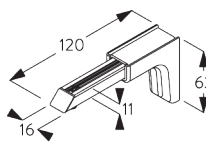

**SG 11154**  
Universal Smart Fix 120 mm

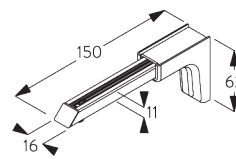

**SG 11155**  
Universal Smart Fix 150 mm

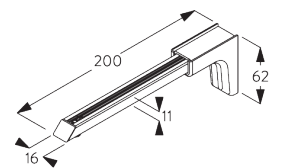

**SG 11156**  
Universal Smart Fix 200 mm

# SYSTEM OPTIONS

## A. WAVE

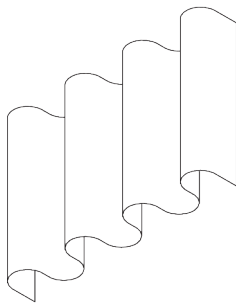

SG 11295

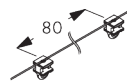

SG 11302

Standard components:

- SG 11295 End stop
- SG 11302 Wave 2C glider cord 80 mm

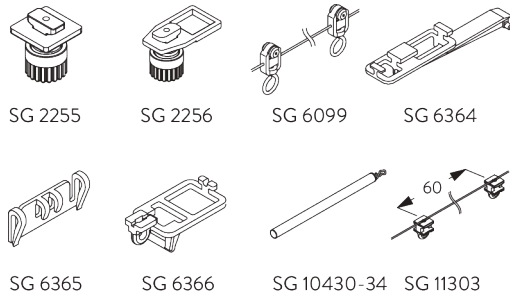

**Optional components (min. radius: >25 cm):**

- SG 2255 Brake
- SG 2256 Brake
- SG 6099 Wave roller cord 80 mm
- SG 6364 Wave extension
- SG 6365 Wave hanger
- SG 6366 Wave carrier for draw rod
- SG 10430-34 Draw rod
- SG 11303 Wave 2C glider cord 60 mm

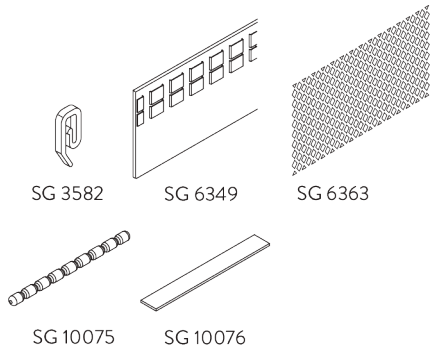

**Curtain components:**

- SG 3582 Hook
- SG 6349 Wave curtain tape
- SG 6363 Wave top hemming tape
- SG 10075 Lead weight 50 gr/m
- SG 10076 Fabric weight

**Wave stack depth - 2C glider cord (standard components)**

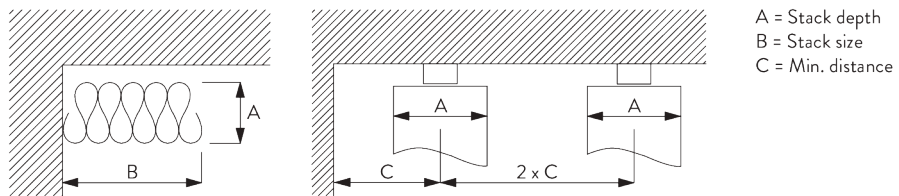

A = Stack depth  
 B = Stack size  
 C = Min. distance



2C Glider cord SG 11302	Pockets between hooks	Approx. curtain fullness	Stack depth A	Stack size B*	Min distance C
80	6	~2.1	140	180 per metre of track	90
80	7	~2.3	160	180 per metre of track	100

2C Glider cord SG 11303	Pockets between hooks	Approx. curtain fullness	Stack depth A	Stack size B*	Min distance C
60	4	~2.1	100	230 per metre of track	70
60	5	~2.3	120	230 per metre of track	80





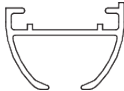
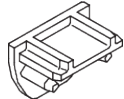

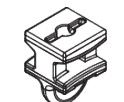

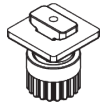
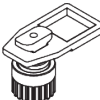

\*Stack size B when using optional extension arm SG 6364 increases by 95 mm per curtain stack!

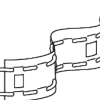



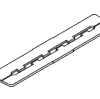
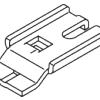

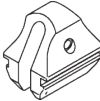

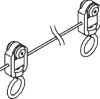

# PARTS

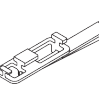
## A. STANDARD PARTS

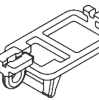
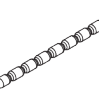
	<b>SG 3825</b> Clamp
	<b>SG 6010p</b> Profile
	<b>SG 6018</b> End cover
	<b>SG 6065</b> End stop
	<b>SG 11300</b> 2C glider

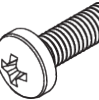
## B. OPTIONAL PARTS

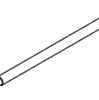
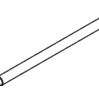
	<b>SG 2255</b> Brake
	<b>SG 2256</b> Brake
	<b>SG 3020</b> Hook
	<b>SG 3562</b> Heading tape
	<b>SG 3571</b> Hook
	<b>SG 3582</b> Hook
	<b>SG 3599</b> Hook
	<b>SG 3802</b> Connection bridge
	<b>SG 3832</b> Bracket
	<b>SG 6053</b> Spring stop
	<b>SG 6064</b> End stop
	<b>SG 6086</b> Spring stop
	<b>SG 6098</b> Roller
	<b>SG 6099</b> Wave roller cord 80 mm

	<b>SG 6283</b> Roller
	<b>SG 6349</b> Wave curtain tape
	<b>SG 6363</b> Wave top hemming tape
	<b>SG 6364</b> Wave extension
	<b>SG 6365</b> Wave hanger
	<b>SG 6366</b> Wave carrier for draw rod
	<b>SG 10075</b> Lead weight 50 g/m
	<b>SG 10076</b> Fabric weight
	<b>SG 10277</b> Pan head screw M4x12
	<b>SG 10407</b> Pan head screw M4x10
	<b>SG 10430</b> Draw rod 50 cm
	<b>SG 10431</b> Draw rod 75 cm
	<b>SG 10432</b> Draw rod 100 cm
	<b>SG 10433</b> Draw rod 125 cm

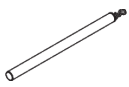

**SG 10434**  
Draw rod 150 cm

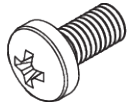

**SG 10492**  
Pan head screw M4x8

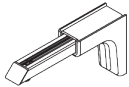

**SG 11154**  
Universal Smart Fix 120 mm

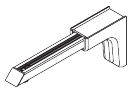

**SG 11155**  
Universal Smart Fix 150 mm

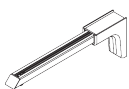

**SG 11156**  
Universal Smart Fix 200 mm

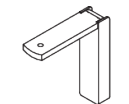

**SG 11200**  
Smart Fix 60 mm

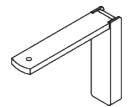

**SG 11201**  
Smart Fix 80 mm

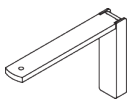

**SG 11202**  
Smart Fix 100 mm

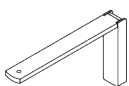

**SG 11203**  
Smart Fix 120 mm

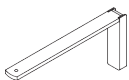

**SG 11204**  
Smart Fix 150 mm



**SG 11205**  
Smart Fix 200 mm

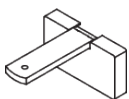

**SG 11210**  
Square Smart Fix 60 mm

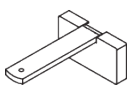

**SG 11211**  
Square Smart Fix 80 mm

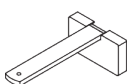

**SG 11212**  
Square Smart Fix 100 mm

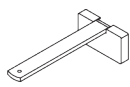

**SG 11213**  
Square Smart Fix 120 mm

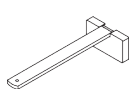

**SG 11214**  
Square Smart Fix 150 mm

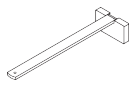

**SG 11215**  
Square Smart Fix 200 mm

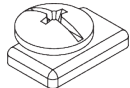

**SG 11295**  
End stop



**SG 11301**  
2C glider on strip

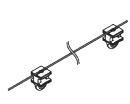

**SG 11302**  
Wave 2C glider cord 80 mm

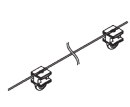

**SG 11303**  
Wave 2C glider cord 60 mm