

SG 1025

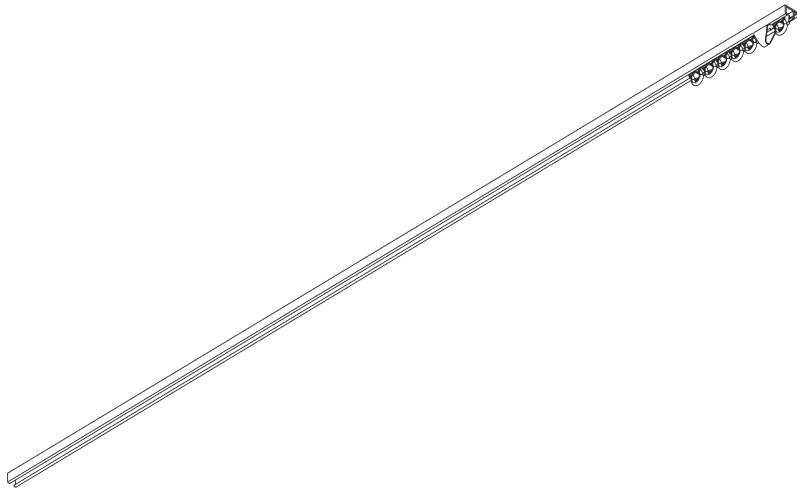
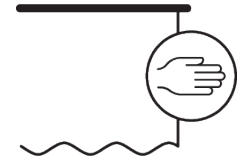

PRODUCT INFORMATION

- **Operation:** hand
- **Range:** S
- **Fitting:** ceiling
- **Colours:** white RAL 9016; special colours or anodised aluminum possible
- **Fabrics:** refer to Silent Gliss fabric collection

Features:

- Pre-drilled profile
- Bendable

SYSTEM SPECIFICATIONS

A. PROFILE

Profile and bending information

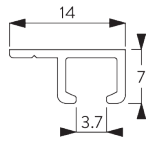

SG 1025p

Profile

Radius:
✓ 6 cm, 10 cm

B. HOW TO MEASURE

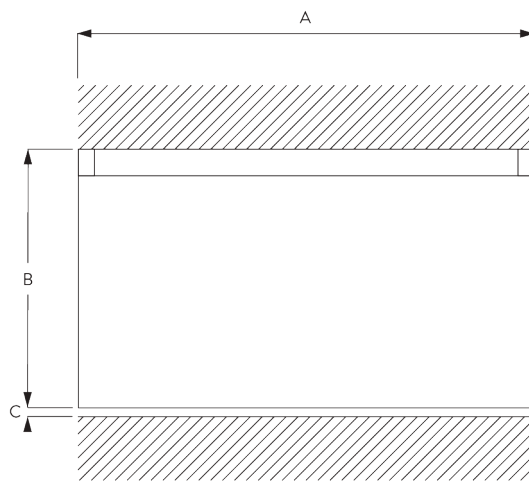

A: System width

B: System height

C: Distance between floor and fabric

C. SPECIFICATION TEXT

Silent Gliss SG 1025 Hand Operated Curtain Track System. Comprises aluminium profile SG 1025 supplied made to measure powder coated white/ silver anodised with gliders SG 3533 at 14/m and 2 end stops SG 3016 per length. Top fixed to timber only with screw SG 6835 at max. 300 mm centres.

FITTING

A. FITTING INFORMATION

Fixing points

For detailed fitting information, visit the Silent Gliss website.

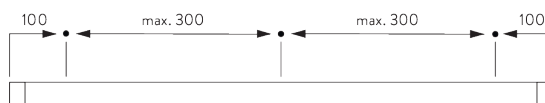

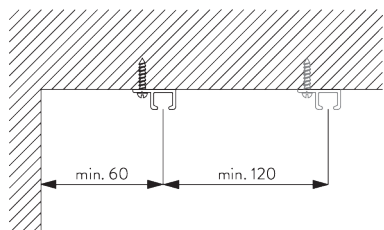

B. CEILING FITTING

Direct into wood





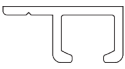

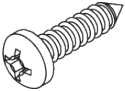



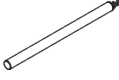

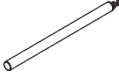
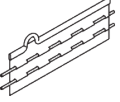
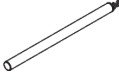

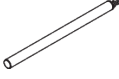
PARTS

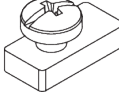
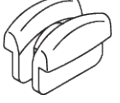
A. STANDARD PARTS

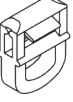
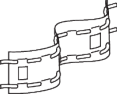
	SG 1025p Profile
	SG 3016 End stop
	SG 3533 Glider
	SG 10896 Pan head screw 2.9x13

B. OPTIONAL PARTS

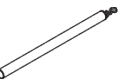
	SG 3020 Hook		SG 10431 Draw rod 75 cm
	SG 3032 Spring stop		SG 10432 Draw rod 100 cm
	SG 3068 Frizzing tape		SG 10433 Draw rod 125 cm
	SG 3070 End stop		SG 10434 Draw rod 150 cm
	SG 3071 End stop		SG 11335 End stop
	SG 3511 Glider		
	SG 3534 Glider 3533 on strip		
	SG 3548 Glider		
	SG 3562 Heading tape		
	SG 3570 Glider		
	SG 3571 Hook		
	SG 3582 Hook		
	SG 3599 Hook		
	SG 10430 Draw rod 50 cm		