

# SG 6243

---

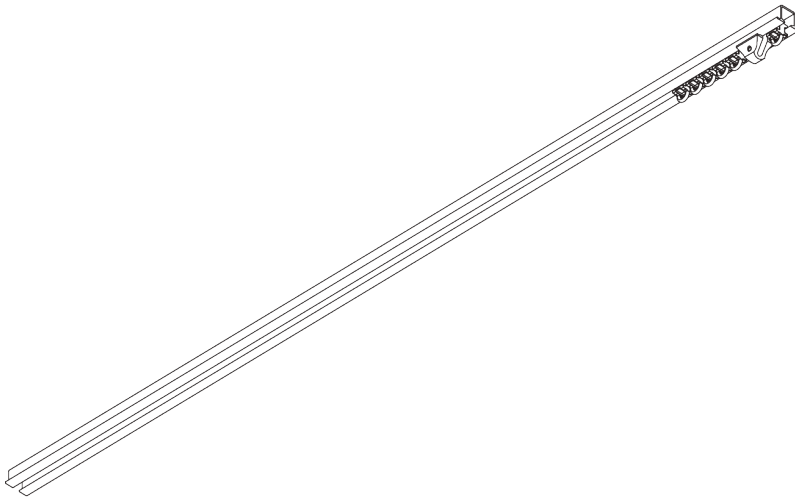
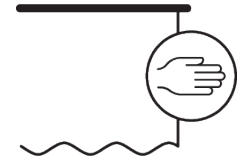

## PRODUCT INFORMATION

- **Operation:** hand
- **Range:** S - M
- **Fitting:** recess
- **Colours:** white RAL 9016, black RAL 9005 or anodised aluminum, special colours possible
- **Fabrics:** refer to Silent Gliss fabric collection

### **Features:**

- 2-component (2C) glider technology
- Wave (2C)
- Bendable
- Pre-drilled profile

# SYSTEM SPECIFICATIONS

## A. PROFILE

Profile and bending information

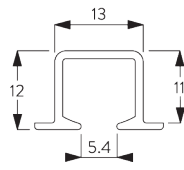

SG 6243p

Profile

Radius:  
20 cm, >25 cm

## B. HOW TO MEASURE

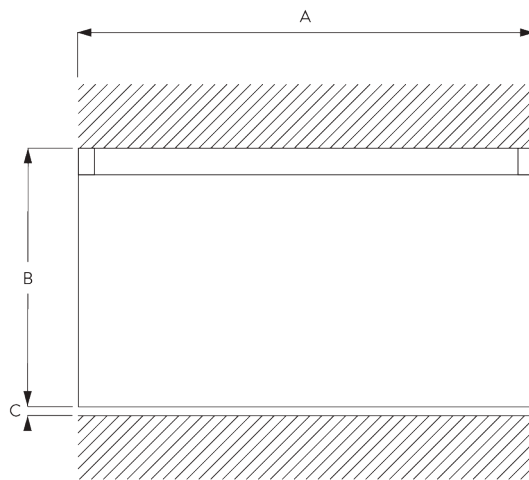

A: System width  
B: System height  
C: Distance between floor and fabric

## C. SPECIFICATION TEXT

**Silent Gliss SG 6243 Hand Operated Curtain Track System.** Comprises aluminium profile SG 6243 supplied made to measure powder coated white with gliders SG 11300 at 14/m, 1 end stop SG 6065 and 1 spring stop SG 6053 per length. Top fixed with screw SG 0240 into timber through pre drilled holes every 200mm.

# FITTING

## A. FITTING INFORMATION

For detailed fitting information, visit the Silent Gliss website.

Fixing points

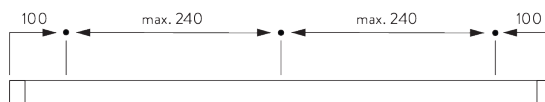

## B. RECESS FITTING

Direct into wood

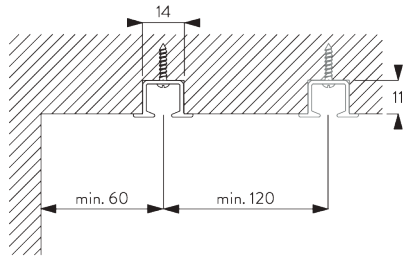

Recess channel: 11 x 14 mm

# SYSTEM OPTIONS

## A. WAVE

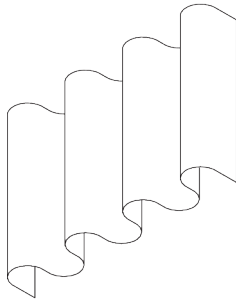

SG 11295

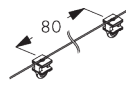

SG 11302

Standard components:

- SG 11295 End stop
- SG 11302 Wave 2C glider cord 80 mm



SG 2255



SG 2256

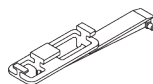

SG 6364



SG 6365

Optional components (min. radius >25 cm):

- SG 2255 Brake
- SG 2256 Brake
- SG 6364 Wave extension
- SG 6365 Wave hanger
- SG 6366 Wave carrier for draw rod
- SG 10430-34 Draw rod
- SG 11303 Wave 2C glider cord 60 mm

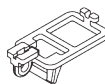

SG 6366

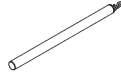

SG 10430-34

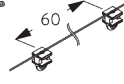

SG 11303

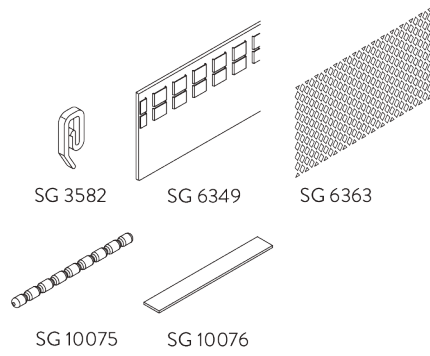

Curtain components:

- SG 3582 Hook
- SG 6349 Wave curtain tape
- SG 6363 Wave top hemming tape
- SG 10075 Lead weight 50 gr/m
- SG 10076 Fabric weight

Wave stack depth - 2C glider cord (standard components)

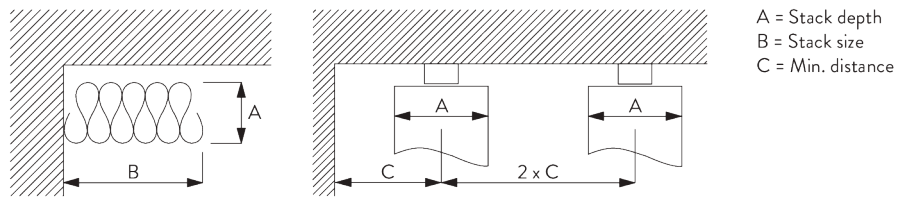

A = Stack depth  
 B = Stack size  
 C = Min. distance

2C Glider cord SG 11302	Pockets between hooks	Approx. curtain fullness	Stack depth A	Stack size B*	Min distance C
80	6	~2.1	140	180 per metre of track	90
80	7	~2.3	160	180 per metre of track	100

2C Glider cord SG 11303	Pockets between hooks	Approx. curtain fullness	Stack depth A	Stack size B*	Min distance C
60	4	~2.1	100	230 per metre of track	70
60	5	~2.3	120	230 per metre of track	80

\*Stack size B when using optional extension arm SG 6364 increases by 95 mm per curtain!

# PARTS

## A. STANDARD PARTS



**SG 6053**

Spring stop



**SG 6065**

End stop

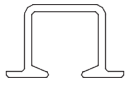

**SG 6243p**

Profile

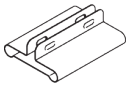

**SG 7002**

Profile protector



**SG 10717**

Countersunk head screw 2.2x19



**SG 11300**

2C glider

## B. OPTIONAL PARTS

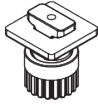

**SG 2255**

Brake

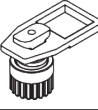

**SG 2256**

Brake

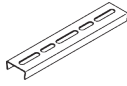

**SG 3067**

Connection bridge

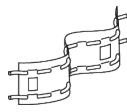

**SG 3562**

Heading tape



**SG 3571**

Hook



**SG 3582**

Hook



**SG 3599**

Hook



**SG 6064**

End stop



**SG 6094**

Roller



**SG 6098**

Roller

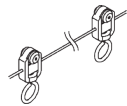

**SG 6099**

Wave roller cord 80 mm



**SG 6283**

Roller

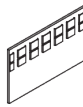

**SG 6349**

Wave curtain tape

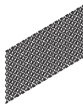

**SG 6363**

Wave top hemming tape

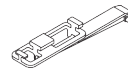

**SG 6364**

Wave extension

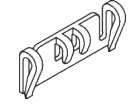

**SG 6365**

Wave hanger

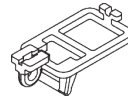

**SG 6366**

Wave carrier for draw rod



**SG 10075**

Lead weight 50 g/m

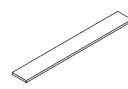

**SG 10076**

Fabric weight



**SG 10430**

Draw rod 50 cm



**SG 10431**

Draw rod 75 cm



**SG 10432**

Draw rod 100 cm



**SG 10433**

Draw rod 125 cm



**SG 10434**

Draw rod 150 cm

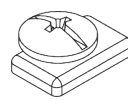

**SG 11295**

End stop



**SG 11301**

2C glider on strip

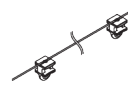

**SG 11302**

Wave 2C glider cord 80 mm

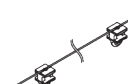

**SG 11303**

Wave 2C glider cord 60 mm





