

# SG 6100

---

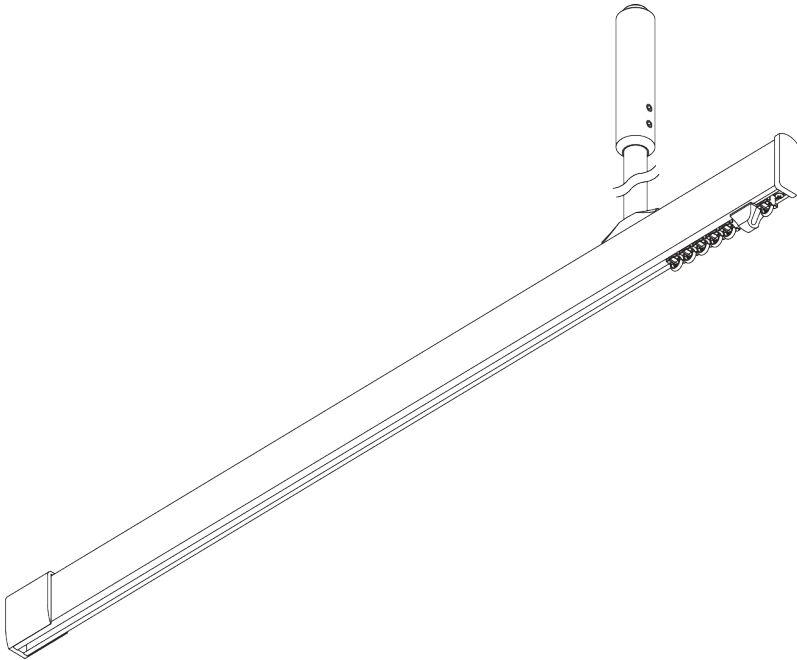
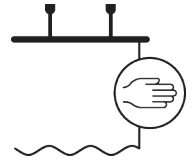

## PRODUCT INFORMATION

- **Operation:** hand
- **Range:** S - L
- **Fitting:** suspended, ceiling, wall
- **Colours:** white RAL 9016, black RAL 9005 or anodised aluminum, special colours possible
- **Fabrics:** refer to Silent Gliss fabric collection

### **Features:**

- Universal room divider
- 2-component (2C) glider technology
- Wave (2C)
- Suspended
- Versatile layouts
- Bendable
- White paint incorporates anti-microbial coating as standard

# SYSTEM SPECIFICATIONS

## A. PROFILE

Profile and bending information

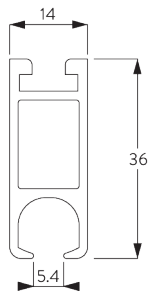

SG 6101

Profile

Radius:  
20 cm, >25 cm

## B. HOW TO MEASURE

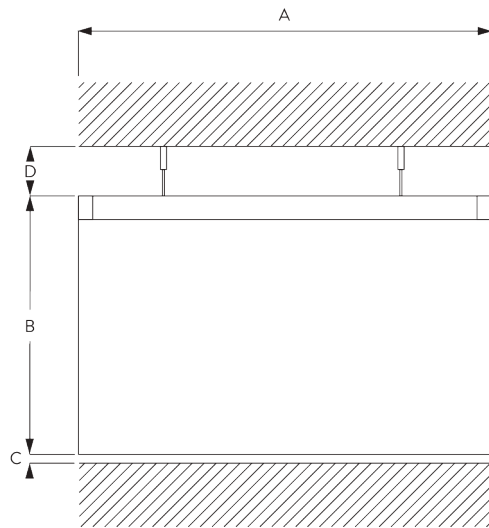

A: System width  
B: System height  
C: Distance between floor and fabric  
D: Distance between ceiling and system

## C. SPECIFICATION TEXT

**Silent Gliss SG 6100 Cubicle Track System.** Comprises aluminium profile SG 6101 in satin anodised / white / black powder coated finish supplied made to measure with nylon glider hook SG 6147 at 10/m. Installed with the following parts depending on the system configuration: Delrin wall support SG 6609 / Dust cover SG 6110 / Ceiling fix bracket SG 6137 / Wall bracket SG 6503 / T bracket SG 6514 / Twist fixing plate SG 6124 / Ceiling fix bracket SG 6138 / Ceiling support SG 6175 / Internal bridge SG 6199 / Connecting bridge SG 6512 / Cross connection SG 6525 / End cover SG 6611 / Hanger rod SG 6190 / V-hanger rod SG 6501.

# FITTING

## A. FITTING INFORMATION

For detailed fitting information, visit the Silent Gliss website.

### Fixing points

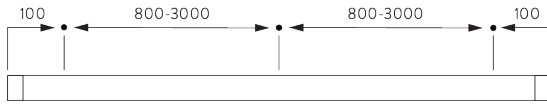

### Dust cover

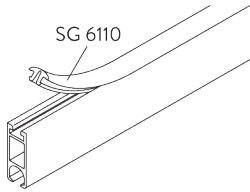

### Site preparation for suspended ceiling applications

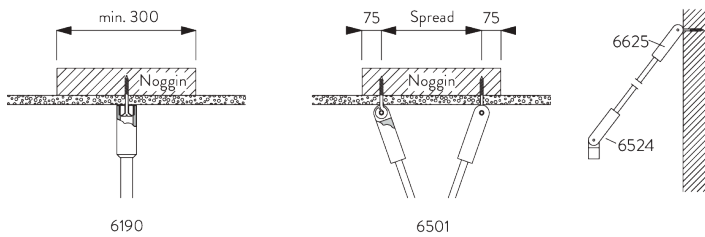

- Fixings should support the ends of the profile and any changes in direction.
- Maximum span between fixings is 3000 mm.
- When fitting to suspended ceilings site preparation is critical.
- At each hanger position a noggin in approved material is required above the suspended ceiling; underside to rest on top of ceiling (but independently supported) with a minimum length of 300 mm at right angles to the track in which the hanger occurs to give fixing tolerance.
- Ideally the hangers should be on the return track, if on the front track then adequate support should be provided.
- A detailed information sheet is available on request.

Diagonal fixing supports can be used to return the hanger to the bedhead wall, but only for use when it is impossible to ceiling fix.

## B. CEILING FITTING

### Hanger SG 6190

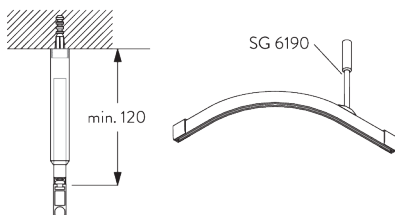

Can also be fixed in suspended ceilings by using sleeves SG 6187 & SG 6188.

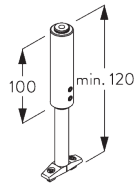

**SG 6190**

*Hanger*

**Mini hanger SG 6175**

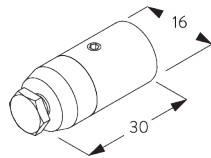
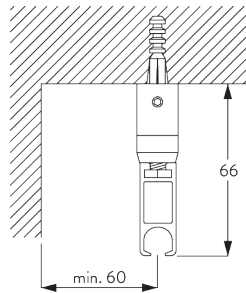

**SG 6175**

*Mini hanger*

**Bracket SG 6124**

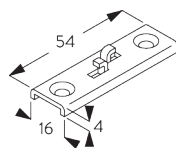
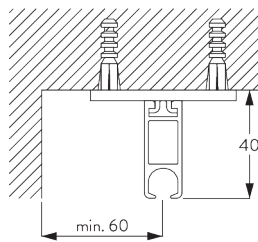

**SG 6124**

*Bracket*

## V-hanger

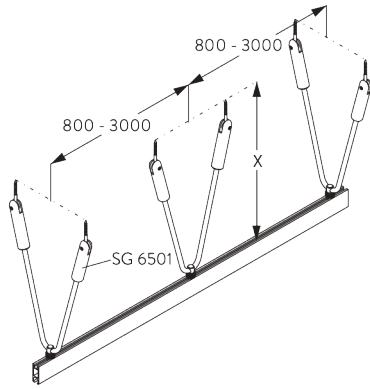

**SG 6501:**  
*V-hangers provide additional lateral stability.*

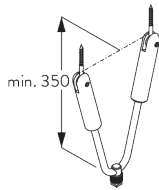

---

**SG 6501**  
*V-Hanger*

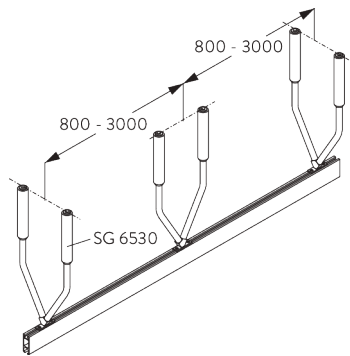

**SG 6530:**  
*V-hangers provide additional lateral stability.*

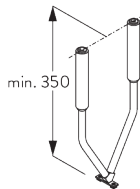

---

**SG 6530**  
*V-Hanger*

## C. WALL FITTING

### Smart Fix

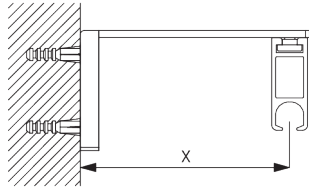

**Smart Fix with slot SG 11206 - SG 11208:**  
Screw SG 10492 (M4x8) needed.

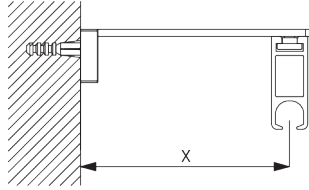

**Square Smart Fix with slot SG 11216 - SG 11218:**  
Screw SG 10492 (M4x8) needed.

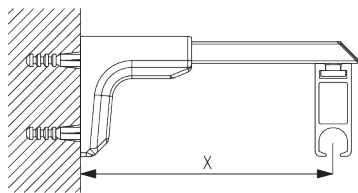

**Universal Smart Fix SG 11154 - SG 11156:**  
Screw SG 11131 (M4x6) needed.

Smart Fix	X mm
SG 11206 / SG 11216	33-51
SG 11207 / SG 11217	53-71
SG 11208 / SG 11218	73-91
SG 11154	102-130
SG 11155	132-160
SG 11156	182-210

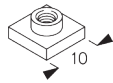

**SG 6117**  
Slot nut



**SG 10492**  
Pan head screw M4x8



**SG 11131**  
Pan head screw with flange  
M4x6

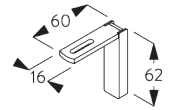

**SG 11206**  
Smart Fix with slot 60 mm

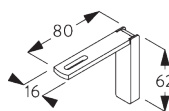

**SG 11207**  
Smart Fix with slot 80 mm

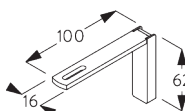

**SG 11208**  
Smart Fix with slot 100 mm

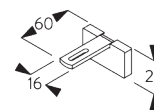

**SG 11216**  
Square Smart Fix with slot 60 mm

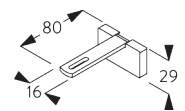

**SG 11217**  
Square Smart Fix with slot 80 mm

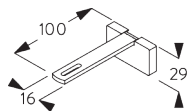

**SG 11218**  
Square Smart Fix with slot  
100 mm

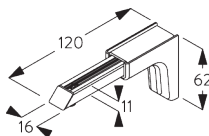

**SG 11154**  
Universal Smart Fix 120 mm

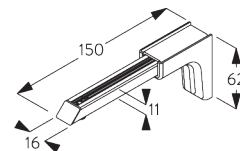

**SG 11155**  
Universal Smart Fix 150 mm

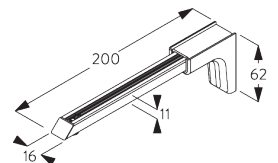

**SG 11156**  
Universal Smart Fix 200 mm

## Wall support SG 6610

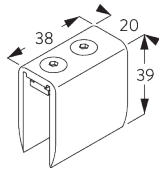
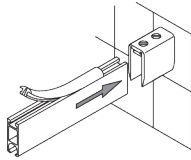

**SG 6610**  
Wall support

## Bracket SG 6503

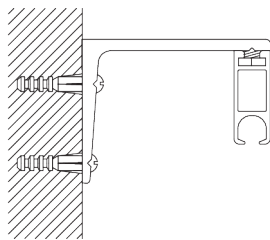

Bracket SG 6503 is available in various sizes, enquire at Silent Gliss.

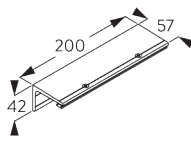

**SG 6503**  
Bracket

## D. PROFILE JUNCTIONS

### Connection bridges SG 6123 & SG 6514

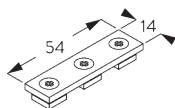
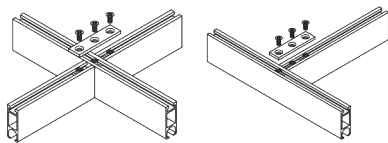

**SG 6123**  
Connection plate

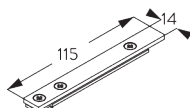

**SG 6514**  
T-Junction

**Connecting bridge  
SG 6512**

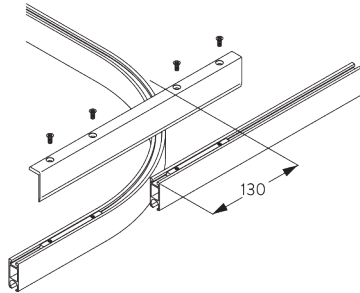
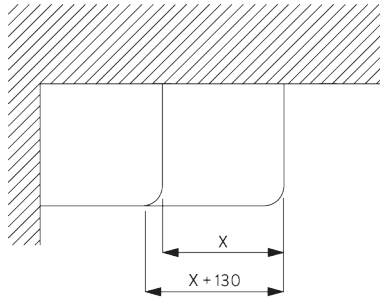

*Note: be sure to attach a sketch!*

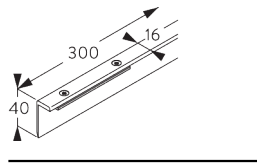

**SG 6512**  
Connection bridge

# SYSTEM OPTIONS

**A. LAYOUT OPTIONS**

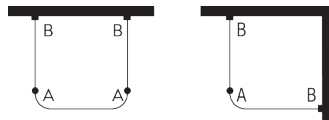

*A: Hanger rod  
B: Wall support*

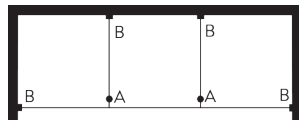

*A: Hanger rod  
B: Wall support*

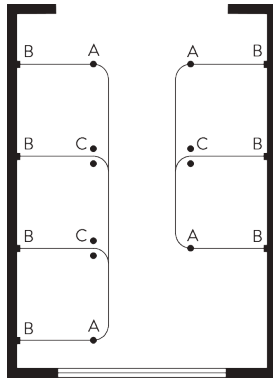

A: Hanger rod  
 B: Wall support  
 C: V-hanger

## B. WAVE

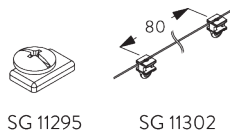
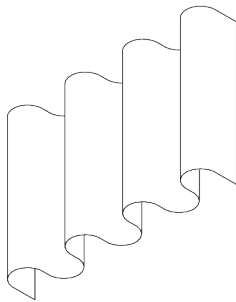

Standard components:

- SG 11295 End stop
- SG 11302 Wave 2C glider cord 80 mm

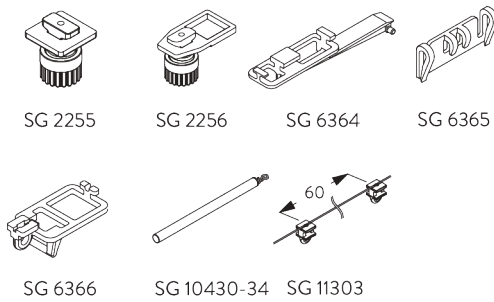

Optional components (min. radius >25 cm):

- SG 2255 Brake
- SG 2256 Brake
- SG 6364 Wave extension
- SG 6365 Wave hanger
- SG 6366 Wave carrier for draw rod
- SG 10430-34 Draw rod
- SG 11303 Wave 2C glider cord 60 mm

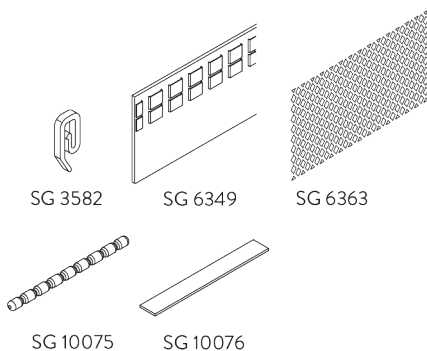

Curtain components:

- SG 3582 Hook
- SG 6349 Wave curtain tape
- SG 6363 Wave top hemming tape
- SG 10075 Lead weight 50 gr/m
- SG 10076 Fabric weight

Wave stack depth - 2C glider cord (standard components)

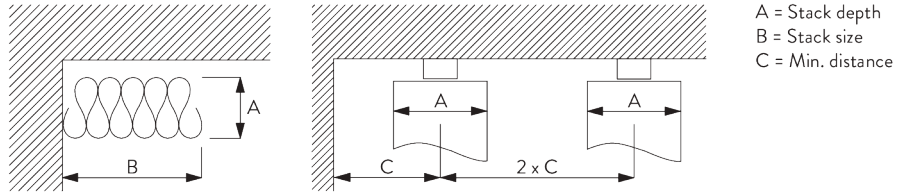

2C Glider cord SG 11302	Pockets between hooks	Approx. curtain fullness	Stack depth A	Stack size B*	Min distance C
80	6	~2.1	140	180 per metre of track	90
80	7	~2.3	160	180 per metre of track	100

2C Glider cord SG 11303	Pockets between hooks	Approx. curtain fullness	Stack depth A	Stack size B*	Min distance C
60	4	~2.1	100	230 per metre of track	70
60	5	~2.3	120	230 per metre of track	80

\*Stack size B when using optional extension arm SG 6364 increases by 95 mm per curtain stack!

# PARTS

## A. STANDARD PARTS



**SG 6065**

End stop



**SG 6086**

Spring stop

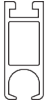

**SG 6101**

Profile



**SG 6143**

Glider on strip



**SG 6190**

Hanger

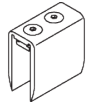

**SG 6610**

Wall support

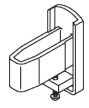

**SG 6611**

End cover

## B. OPTIONAL PARTS

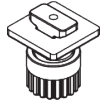

**SG 2255**

Brake

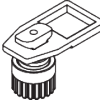

**SG 2256**

Brake



**SG 3582**

Hook



**SG 3599**

Hook



**SG 6094**

Roller



**SG 6098**

Roller



**SG 6110**

Dust cover

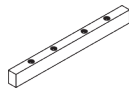

**SG 6112**

Connection bridge

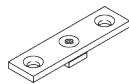

**SG 6115**

Bracket

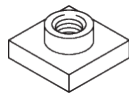

**SG 6117**

Slot nut

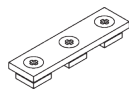

**SG 6123**

Connection plate

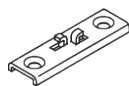

**SG 6124**

Bracket

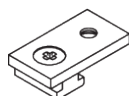

**SG 6137**

Bracket

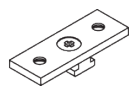

**SG 6138**

Bracket



**SG 6146**

Hook

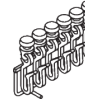

**SG 6147**

Glider with hook on strip

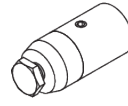

**SG 6175**

Mini hanger

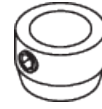

**SG 6187**

Sleeve



**SG 6283**

Roller

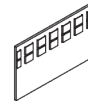

**SG 6349**

Wave curtain tape

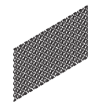

**SG 6363**

Wave top hemming tape

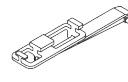

**SG 6364**

Wave extension

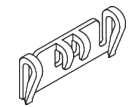

**SG 6365**

Wave hanger

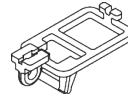

**SG 6366**

Wave carrier for draw rod



**SG 6501**

V-Hanger

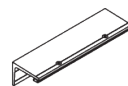

**SG 6503**

Bracket

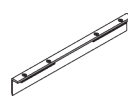

**SG 6512**

Connection bridge

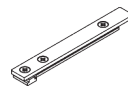

**SG 6514**

T-Junction

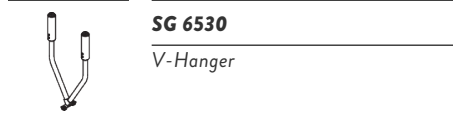

**SG 6530**

V-Hanger

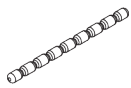

**SG 10075**

Lead weight 50 g/m

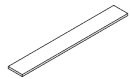

**SG 10076**

Fabric weight

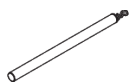

**SG 10430**

Draw rod 50 cm



**SG 10431**

Draw rod 75 cm

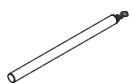

**SG 10432**

Draw rod 100 cm

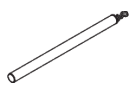

**SG 10433**

Draw rod 125 cm

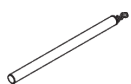

**SG 10434**

Draw rod 150 cm



**SG 10492**

Pan head screw M4x8



**SG 11131**

Pan head screw with flange M4x6

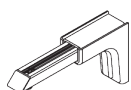

**SG 11154**

Universal Smart Fix 120 mm

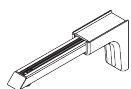

**SG 11155**

Universal Smart Fix 150 mm

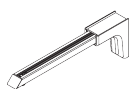

**SG 11156**

Universal Smart Fix 200 mm

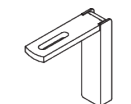

**SG 11206**

Smart Fix with slot 60 mm

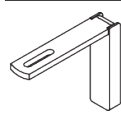

**SG 11207**

Smart Fix with slot 80 mm

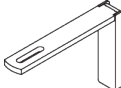

**SG 11208**

Smart Fix with slot 100 mm

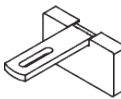

**SG 11216**

Square Smart Fix with slot 60 mm

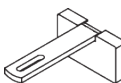

**SG 11217**

Square Smart Fix with slot 80 mm

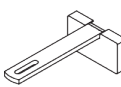

**SG 11218**

Square Smart Fix with slot 100 mm



**SG 11295**

End stop

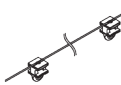

**SG 11302**

Wave 2C glider cord 80 mm

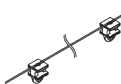

**SG 11303**

Wave 2C glider cord 60 mm